

RPM
LIVESTOCK EQUIPMENT

Cattle Equipment



*Locally made tough,
for Australian cattle*



Geoff Pearson 3rd Generation
Australian Cattle Producer
Proud owner of RPM since 2014

TABLE OF CONTENT



Cattle Crushes

4

| | |
|-----------------------|----|
| Dealer Network | 2 |
| About Us | 3 |
| Cattle Crushes | 4 |
| Headbails & Headlocks | 9 |
| Cattle Crush Options | 10 |
| Calf equipment | 12 |
| Safe - T - Force | 14 |



Safe - T - Force

14

| | |
|--------------------------|----|
| Loading Ramps | 15 |
| Gates | 16 |
| Panels & Yard Bows | 18 |
| Cattleyard Systems | 19 |
| Cattle Equipment Options | 21 |
| Air Equipment | 22 |
| Spare Parts | 23 |

RPM Livestock Dealer Network



A NUTRIEN AG SOLUTIONS BUSINESS

All States

Nutrien
Ag Solutions®

All State

DELTA 
AGRIBUSINESS
NSW|VIC



VIC



VIC|ACT|TAS



All States



PRODUCELINK

WA

AG n VET
Services

NSW

GRAZAG
GRAZING AND AGRICULTURAL PRODUCTION SOLUTIONS

NSW



**Riverland
Trading**

VIC

BROWN|WIGG

VIC



NSW|VIC



QLD

**Cox
Rural**

SA



NSW|QLD



To be come a
RPM Dealer, call
07 5462 3433.



THANK YOU

Hello

Thank you for taking an interest in the range of cattle handling products we manufacture here in Gatton, Queensland for Australian Cattle Producers.

As a cattleman myself, I appreciate the value of needing the equipment to work. You're busy, the cattle are thirsty, getting cranky, and the clock is working against you. The equipment needs to be tough, tougher than the stock you're pushing through, and this is the standard we apply to all RPM Livestock Equipment. Without Exception.

As you go through the catalogue, you will see our products that have proved to be popular for over 25 years. If you need something modified, or a custom configuration, let us know, our draftsman will design a set of specs to suit your operation.

All of RPM's equipment is made in Queensland, we proudly wear the Australian Made logo, so buyers know they are receiving quality, locally produced equipment. The full range equipment is available through our dealer network, as listed on page 2, so you can deal with your local supplier. Alternatively, please feel free to contact the team at Gatton.

Regards

Geoff Dearson



CATTLE CRUSH



Cattle Crushes

RPM have been producing cattle crushes for sale for over 30 years to suit the Australian cattle market. Over this period of time RPM have learnt how to engineer cattle crushers to be tough, heavy duty and last while being safe for the operator and animals. All RPM Cattle Crushers use a hydraulic system as opposed to the ratchet strong-arm squeeze crush option. The use of hydraulics is safer and quicker to release which suits many cattle producers. Even those with young cattle hands or female cattle hands and generally want to provide a safer workplace for their entire team.





Ultimate Cattle Crush

RPM's Ultimate Crush has been used by major cattle producers for over 30 years due to its extra heavy duty build to withstand the highest demands of Beef Producers. The Ultimate is ideal for large commercial beef production and feedlots, its versatile options also suit smaller operations too. The addition of spey and injection gates, gives operators full access to their beasts.

The Ultimate Cattle Crush Standard Features:

- ▲ Heavy duty crush using high tensile galvanised steel
- ▲ Small feedlot/large commercial operation
- ▲ Parallel double sided squeeze
- ▲ Spey & injection gates
- ▲ Rose joint bearing linkage
- ▲ Hydra Lock Headbail and Squeeze
- ▲ Front and rear operation standard
- ▲ Sound proofing
- ▲ Powerlock linkage
- ▲ Choose either: Straight Rubber Lined Doors or our standard Superlock on the Headbail
- ▲ Offside and Nearside Available
- ▲ Hot dipped model available

Weight: 715kgs

Extras (Not included in the standard model)

- ▲ Vetless option available

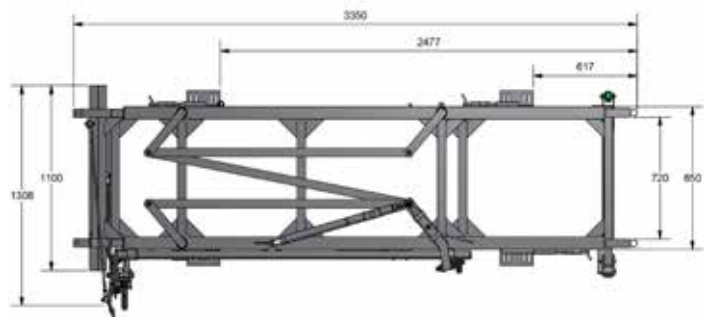
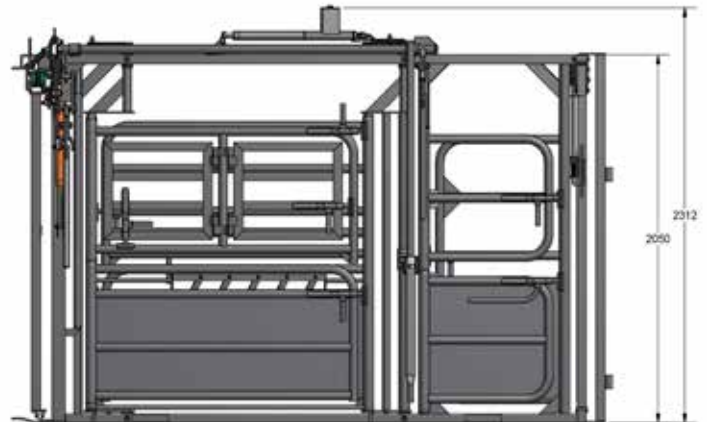

- ▲ Bulk Gate
- ▲ Hydra Headlock or Muger Headlock
- ▲ Welded Drop-In Floor or Timber Floor
- ▲ Semen Gates
- ▲ Fully Sheeted Rear Door

Product Code: Nearside 13000001G, Offside 13000001G-OS



Allrounder Cattle Crush

The RPM Allrounder Crush is our most popular commercial model due to the numerous standard inclusions and quality build to withstand a tough “workout”. The combination of the parallel squeeze, vet access and hydraulic headbail operation has made it the most preferred crush for over 30 years. The Allrounder Crush has a galvanised high-tensile steel construction and is designed to suit any commercial operation. The Allrounder is truly value for money and is also very popular family farm operators looking to have quality cattle handling equipment built to last.

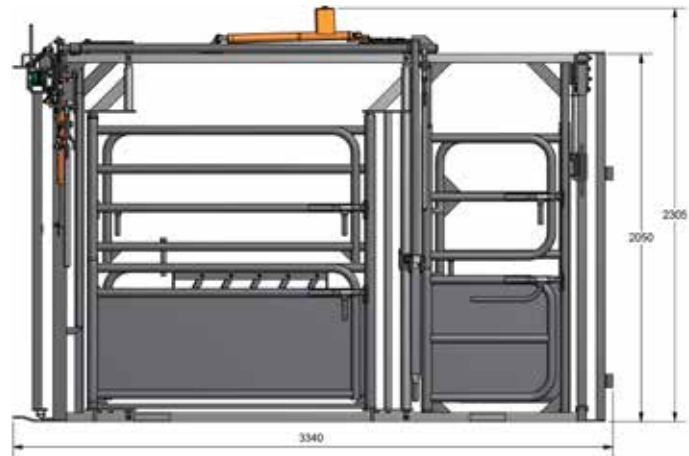

- ▲ Galvanised steel
- ▲ Most popular commercial model
- ▲ Producers large and small
- ▲ Parallel double sided squeeze
- ▲ Rose joint bearing linkage
- ▲ Hydra lock bale squeeze
- ▲ Front & rear operation
- ▲ Sound proofing
- ▲ Power lock linkage
- ▲ Offside and Nearside available
- ▲ Hot dipped model available

Weight: 650 kgs

Extras: Not included in the standard model

- ▲ Vetless option available
- ▲ Baulk Gate

- ▲ Hydra Headlock or Mucker Headlock
- ▲ Welded Drop-In Floor or Timber Floor
- ▲ Spey & Injection Gates
- ▲ Semen Gates
- ▲ Fully Sheeted Rear Door

Product Code: Nearside 12000001G, Offside 12000001G-OS



Innovator Cattle Crush

The RPM Innovator Crush is a new generation, entry-level crush, designed for the budget conscious small to the medium producer, ideally for the family run farm. RPM Livestock Equipment makes sure, entry-level does not mean cheap, imported, low quality. At RPM we use the same all Australian Made standard for the Innovator, with the same galvanised high-tensile steel construction as our other crushes. No sacrifice in quality or features. The Innovator Cattle Crush is fully engineered, using the latest CAD and finite element analysis packages, it is as strong, as it is good-looking.'

- ▲ Medium Duty Crush Using High Tensile Galvanised Material
- ▲ 115x42mm Oval Rail Gates for Anti-Bruise Operation
- ▲ Rose Joint Bearing Linkage
- ▲ Hydra Lock Headbail
- ▲ Bottom Bayonet Squeeze
- ▲ Anti-backing Bar
- ▲ Front and Rear Operation Standard
- ▲ Powerlock II Linkage for Improved Rear Operation
- ▲ Offside and Nearside Available

Weight: 560 kgs

Extras: Not included in the standard model

- ▲ Vetless option available
- ▲ Baulk Gate

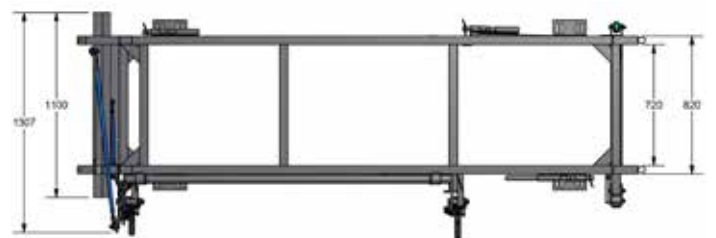
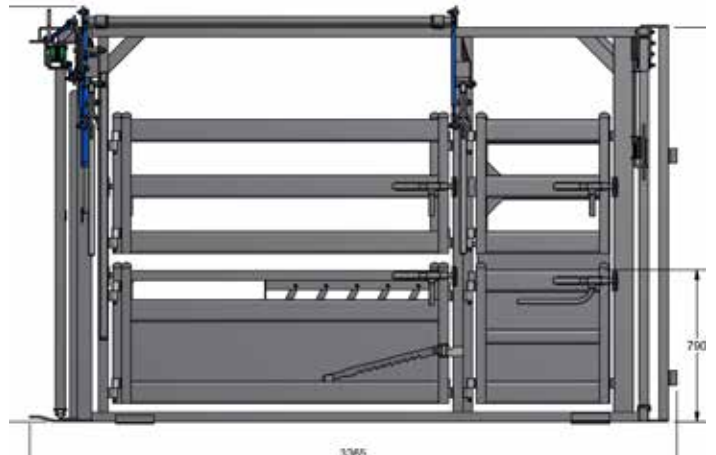

- ▲ Hydra Headlock or Mucker Headlock
- ▲ Welded Drop-In Floor or Timber Floor
- ▲ Spey & Injection Gates
- ▲ Semen Gates
- ▲ Fully Sheeted Rear Door

Product Code: Nearside 11700001-NS, Offside 11700001-OS

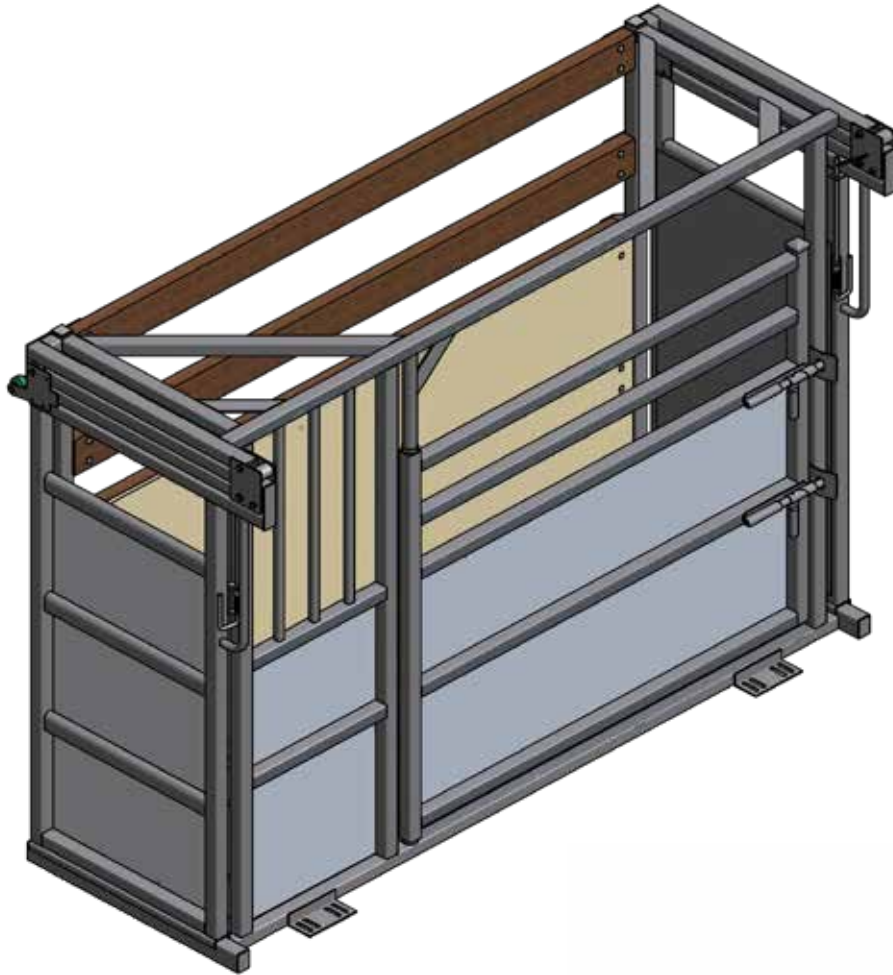

- ▲ Galvanised construction
- ▲ Auto locking sliding gate at front and rear of the box
- ▲ Drafting gate on working side
- ▲ Galvanised floor with anti slip treads
- ▲ Timber & ply panel on non-working side to eliminate any interference to the EID readers
- ▲ Weigh bar mounting plates
- ▲ Offside and Nearside Available

Extras (Not Included)

- ▲ Weigh Scales
- ▲ Indicator

Product Code: Nearside 19001000W-NS, Offside 19001000W-OS

UNIVERSAL SCALE LUGS
TRU-TEST & RUDDWEIGH

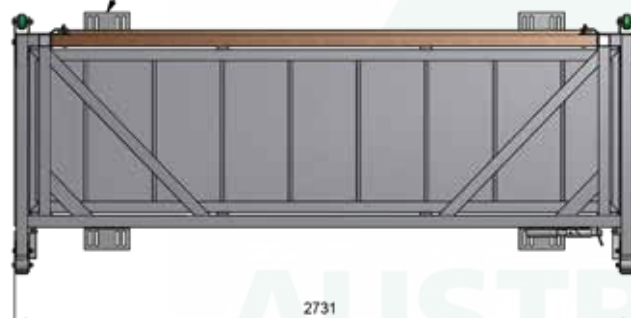



Baulk Gate

- ▲ Galvanised two piece hinged gate
- ▲ Side pinning
- ▲ Quick release pin latch
- ▲ Nearside & offside available
- ▲ Weight - 130kgs approx

Product Code:
Galvanised 17000120-G,
Mugger Headlock
17000128-G



Semen Gate

- ▲ Easy Access for Safe Collection
- ▲ Safety to Both Animal & Operator
- ▲ Slam Shut Handle
- ▲ Heavy duty slam handles
- ▲ Strong hinging system

Product Code: Nearside 17013110,
Offside 17013110-OS

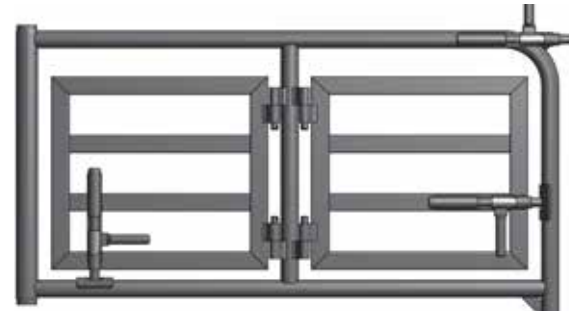

Spey & Injection Gates

- ▲ Easy Access to Body of Animal
- ▲ Slam Shut Handles
- ▲ Strong Hinging System

Product Code: Nearside 17013011-G,
Offside 17013011-GOS



Timber Floor

- ▲ Treated hardwood
- ▲ Anti-slip cleats
- ▲ Quiet for easy throughput

Product Code:
17000070-ULT



Steel Floor

- ▲ Galvanised floor
- ▲ 3mm gal sheeting
- ▲ Anti-Slip Cleats
- ▲ Weld, bolt or drop in option

Product Code: 17000080-G



Rubber Floor

- ▲ Galvanised main frame
- ▲ Less noise with 10mm rubber lining
- ▲ Anti-Slip Cleats
- ▲ Weld, bolt or drop in option

Product Code: 17000080-R

Sheeted Rear Door



- ▲ Completely blocks off animal's view
- ▲ Total protection for animal & operator
- ▲ 1.6mm gal sheet
- ▲ 75x40x2mm rails to reduce noise

Product Code:
Nearside 16000160-G,
Offside 16000160-GOS

Rear Door Front Op

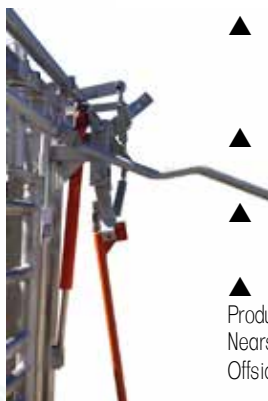

- ▲ Operate rear door from the front
- ▲ Ideal for one man operation
- ▲ Drop away safety handle
- ▲ Reduces labour

Product Code:
Nearside 17000158,
Offside 17000158-OS

To order your options

for improved production functions

☎ 07 5462 3433

@ sales@rpmrural.com

🌐 rpmrural.com



RPM
LIVESTOCK EQUIPMENT

*Locally made tough,
for Australian cattle*



HEADBAILS & HEADLOCKS

The Headbail and Headlocks produced by RPM Livestock Equipment are designed to quickly capture your cattle so it does not get injured and the operator is safe. Built from tough Australian steel they have proved so popular over the years, many Cattle producers have replaced other brands

with a genuine RPM Head Bail and Head Lock to their crush.

The RPM Head Bail use a manual hydraulic locking system designed for quick capture and release, also with a rear operating option for increased safety for the operator and beast is available.



Superlock Headbail

- ▲ Hydra Lock—Manual Hydraulic Locking
- ▲ The hydraulic ram allows infinite locking
- ▲ Quick and easy release when it is under pressure
- ▲ Full Walk Through
- ▲ Greasable Rose Joint Linkages
- ▲ Powerlock with 30% More Power for Effort
- ▲ Nearside and Offside operation available

Weight 165 kgs

Extras: Not included in the standard model

- ▲ Straight rubbed lined doors or Yoke Style Doors
- ▲ Hydra Headlock or Muger Headlock
- ▲ Rear Operation Kit

Product Code: Nearside 16001000G, Offside 16001000G-OS

Superlock Headbail HOT DIPPED GALVANISED

Product Code: Nearside 16001000G, Offside 16001000G-OS



Rear Operation Kit

Add kit to the Superlock Headbail

The kit allows the operator to open and close the headbail from a rear position. Providing more efficiencies for the operator if they are working on their own. The kit can be easily bolted or welded to an existing race/crush frame.

Note: Pipe extension not included as standard.

Product Code: Nearside 16000160-G, Offside 16000160-GOS



Hydra Headlock

Standard Features:

- ▲ Hydra Lock—Manual Hydraulic Locking
- ▲ The hydraulic ram allows infinite locking
- ▲ Quick and easy release when it is under pressure
- ▲ Full Walk Through
- ▲ Greasable Rose Joint Linkages
- ▲ Powerlock with 30% More Power for Effort
- ▲ Nearside and Offside operation available

Weight 165 kgs

Extras: Not included in the standard model

- ▲ Straight rubber lined doors or Yoke Style Doors
- ▲ Hydra Headlock or Muger Headlock
- ▲ Rear Operation Kit

Product Code: Nearside 17001000G, Offside 17001000G-OS



Muger Headlock

- ▲ Heavy Duty headlock
- ▲ Scoop can be adjusted along the bottom arm
- ▲ Scoop on the bottom arm prevents the amount of side-to-side movement of the animals head
- ▲ Top restraining arm is designed to restrict the animal from throwing their head up
- ▲ Ideal for when treatment on the animal's head is required (eg. mouthing, eye treatment)
- ▲ Manual hydraulic ram allows for infinite locking
- ▲ A quick release handle on the top of the ram, allows for instant release of the animal's head
- ▲ Full Walk Through
- ▲ Not included: Superlock Headbail is additional price
- ▲ Can be easily bolted onto the Superlock Headbail

Weight: 34 kgs

NOTE: The bottom arm can be interchanged with a Hydra Headlock (pipe)arm

Product Code: Nearside 17002000, Offside 17002000-OS



Rubber Yoke Style Rubber Doors

- ▲ Heavy duty rubber lined doors
- ▲ Provides a position for animal's head

Product Code: 16006000



Rubber Straight Headbail Doors

- ▲ Heavy duty rubber lined doors
- ▲ Less rigid on the animal's neck

Product Code: 16006100



CALF CRADLE



RPM Calf Cradle

The solution offered by RPM for handling calves has been especially designed to maximise the safety of the young stock, is purpose built tough, just like RPM's Cattle Crushers. The Calf Cradle and Calf Race equipment will improve production, with easy to operate foot and hand controls for the operator. If you would like to know more call 07 5462 3433 or visit www.rpmrural.com.

- ▲ Calf Handling Made Easier
- ▲ Heavy duty galvanised steel
- ▲ Table style cradle
- ▲ Improved OH&S
- ▲ Hydra Lock Technology allowing infinite clamping adjustment
- ▲ Foot and Hand Operation
- ▲ Head rest for improved safety and efficient operation
- ▲ Cowl infill for increased animal and operator safety
- ▲ Nearside and offside operation available

Weight 160 kgs

Product Code: 22003600

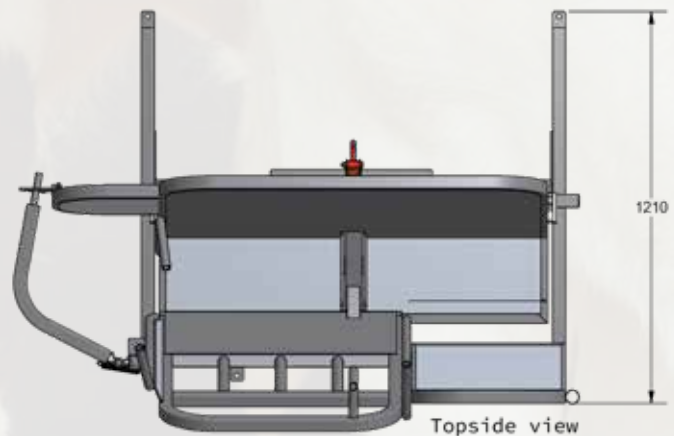
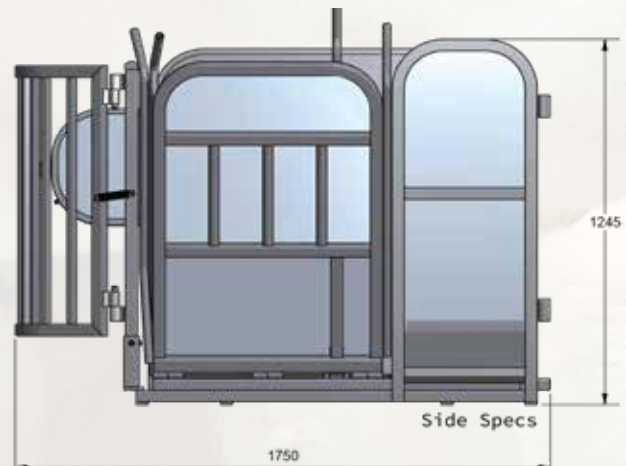

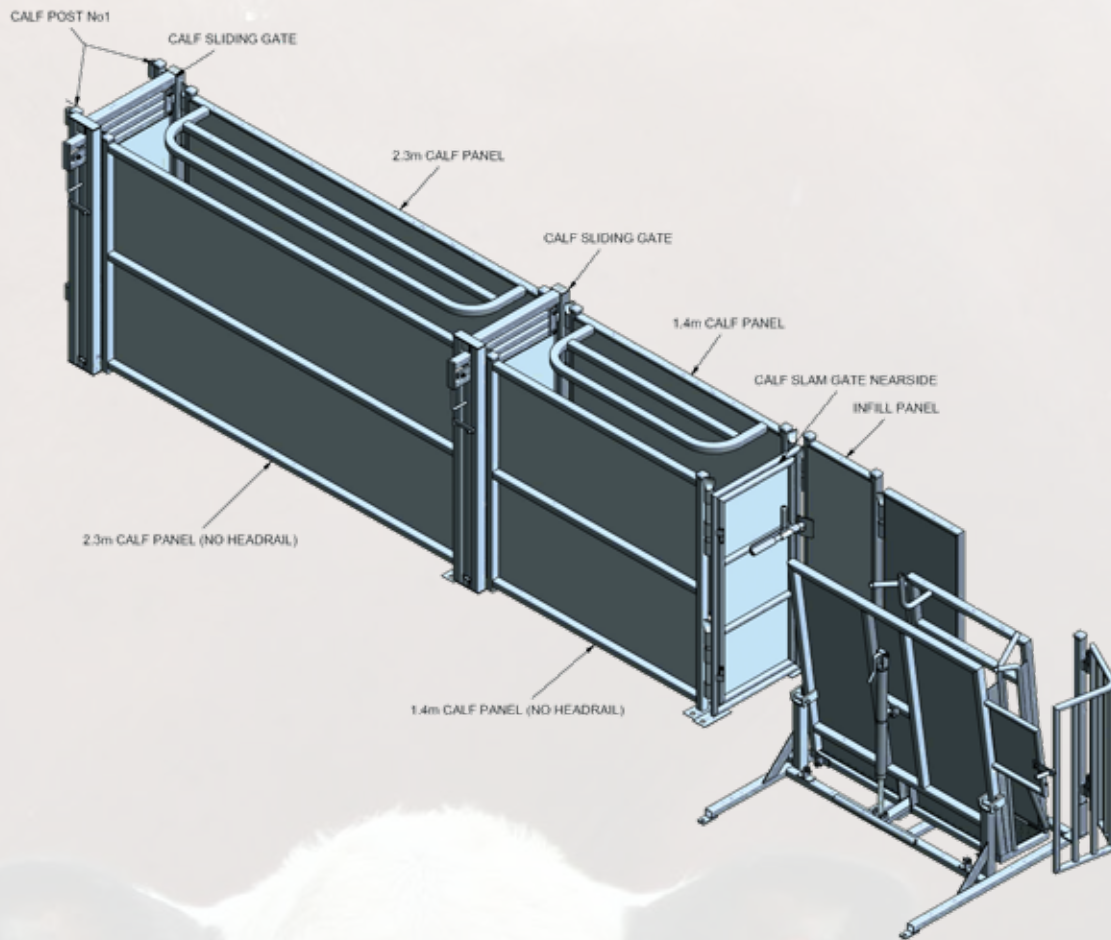

Stand Alone Calf Race

- ▲ Galvanised construction
- ▲ Headrail to prevent the calf from jumping up
- ▲ Fully sheeted to improve flow of calves by reducing the impact of distraction
- ▲ Calf panels can be made to any length to accommodate an existing yard setup

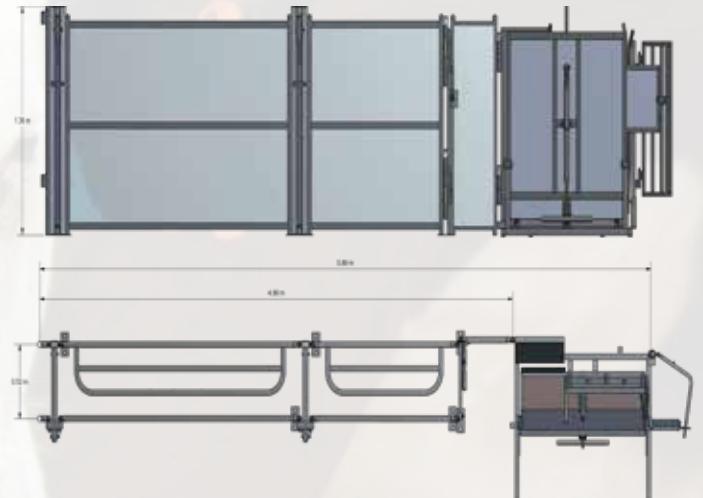

Calf Race (Against Adult Race)

- ▲ Galvanised construction
- ▲ Headrail to prevent the calf from jumping up
- ▲ Fully sheeted to improve the flow of the calves by reducing the impact of distraction
- ▲ Calf panels can be made to any length to accommodate an existing yard setup
- ▲ Connect to the adult race by adding a diversion gate in the race ~ allowing you to draft the calves out of the adult race
- ▲ Nearside & offside available

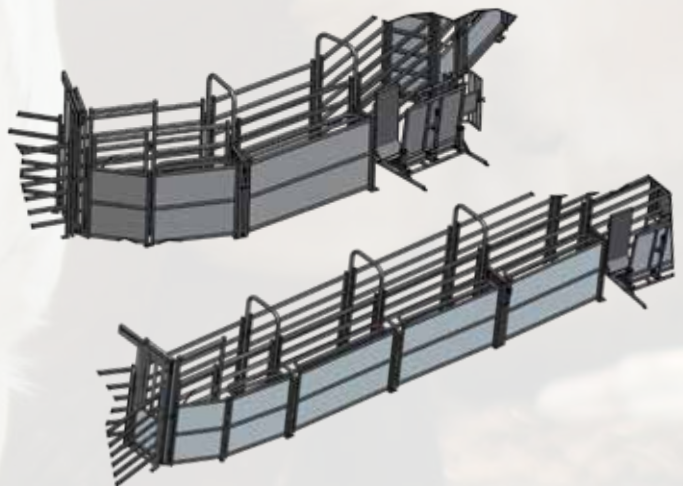

SAFE - T - FORCE



*Locally made tough,
for Australian cattle*



The Safe-T-Force is a galvanized manual system designed for a safer and more efficient way to handle cattle. This fully sheeted system is also designed to improve the natural flow of cattle from the Safe-T-Force through the race and into the cattle crush. The Safe-T-Force allows the operator to push the cattle around with a unique automatic brake locking gate, making it safer for both the animal and the operator.

Safety is a key element in yard systems today, and we have designed an elevated walkway with a handrail and a set of stairs at each end of the walkway. Additionally, a special handle can be added to this system, which allows the operator to control the Safe-T-Force whilst being out of harms way.

We offer this system as a 2 section or a 3 section with either nearside or offside operation.

Key Points:

- ▲ Galvanized construction
- ▲ Enhanced time management
- ▲ Improved cattle flow and OH&S
- ▲ Unique auto brake locking gate
- ▲ 3 metre available in 2 Section and 3 Section
- ▲ 3 metre available in 4 Section (*special yards only)

Optional Extras (not included)

- ▲ Walkway and handrail

Weight:

- ▲ 2 Section STF - 315 kgs
- ▲ 3 Section STF - 395 kgs

3m 2 Section Safe-T-Force

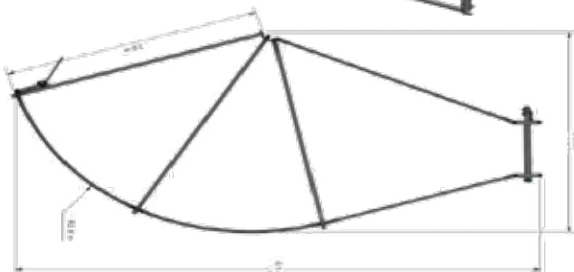

Product Code: Nearside 23533200, Offside 23533200-OS

3m 3 Section Safe-T-Force

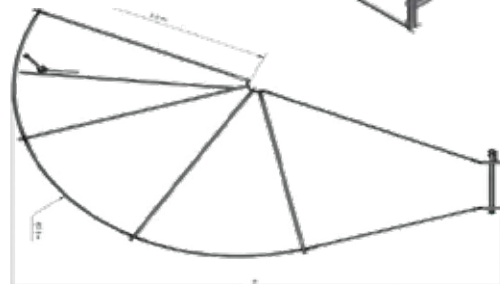
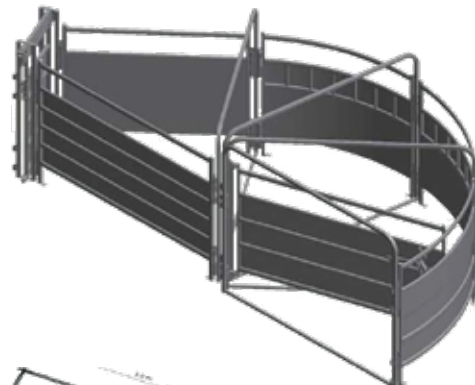

Product Code: Nearside 23533300 Offside 23533300-OS

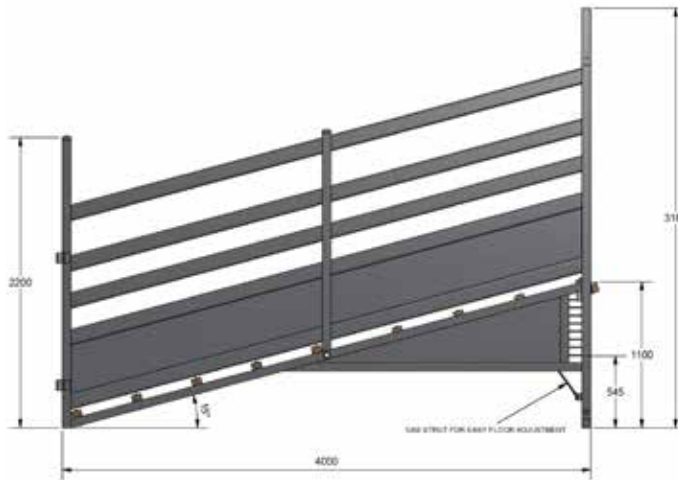

4 Meter Adjustable Loading Ramp

- ▲ 4 metre long ramp
- ▲ Height adjustable with a unique gas strut to assist with floor adjustment
- ▲ Hardwood floor
- ▲ Cattle rail 115x42x2mm
- ▲ Anti-slip treads
- ▲ Sheeted lower section for push safety
- ▲ Walkway and handrail additional option

Weight: 540 kgs

Product Code: 21501500

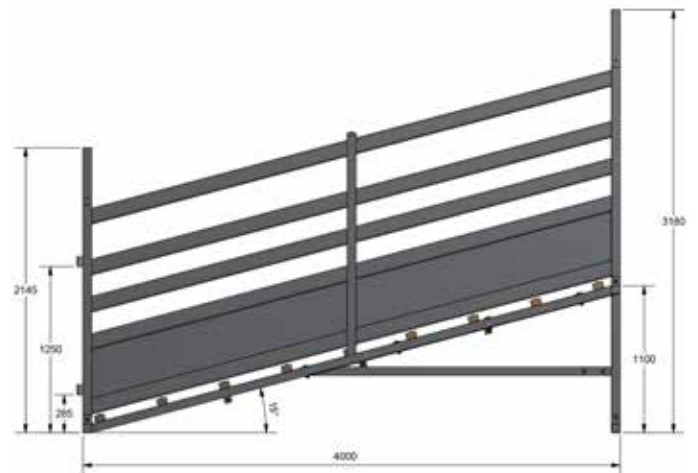

4 Meter Fixed Height Loading Ramp

- ▲ 4 metre long ramp
- ▲ Fixed height
- ▲ Hardwood floor
- ▲ Cattle rail 115x42x2mm
- ▲ Anti-slip treads
- ▲ Sheeted lower section for push safety
- ▲ Walkway and handrail additional option

Weight: 530kgs

Product Code: 21501450

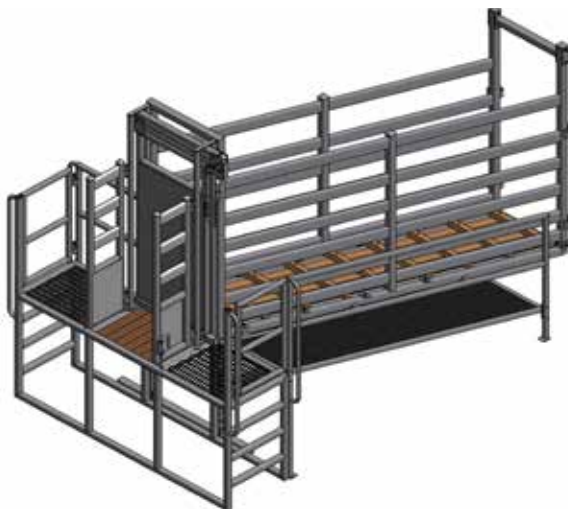

Deluxe Loading Ramp

- ▲ 4.7 metre long ramp
- ▲ Wings and extender for side loading
- ▲ Hardwood floor
- ▲ Cattle rail 115x42x2mm
- ▲ Anti-slip treads
- ▲ Sheeted lower section for push safety
- ▲ Handrails and walkway for operator safety - can have on Nearside or Offside
- ▲ Complies with Australian standards

Product Code: 21503300

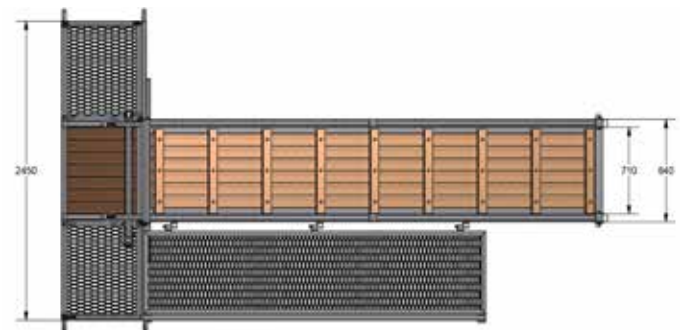

Walkway & Handrail (Optional)

- ▲ Safety conscious flooring with grip span plank
- ▲ Anti-slip walkway
- ▲ Allows the operator more access to the animal if required
- ▲ Can have on Nearside or Offside of the loading ramp
- ▲ Complies with Australian standards

Product Code: 21502002



YARD GATES

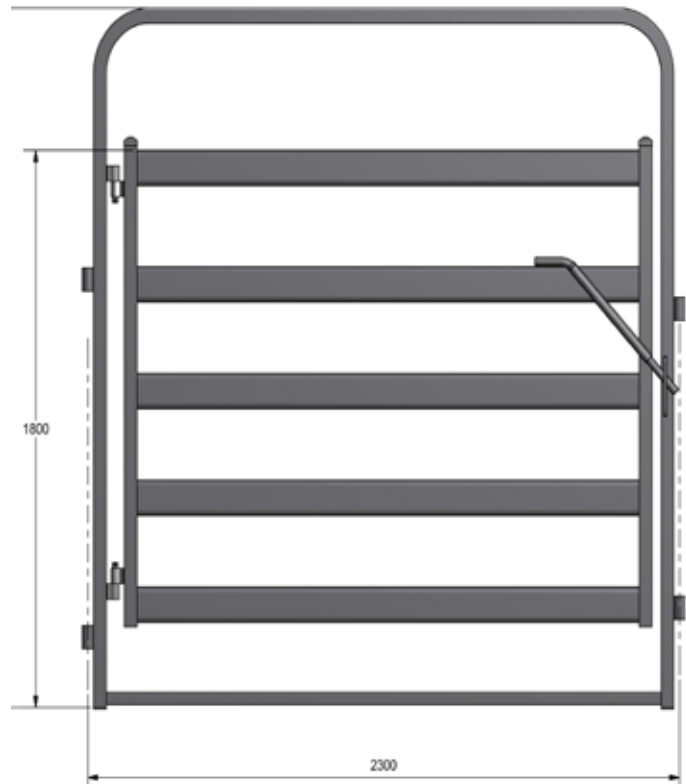
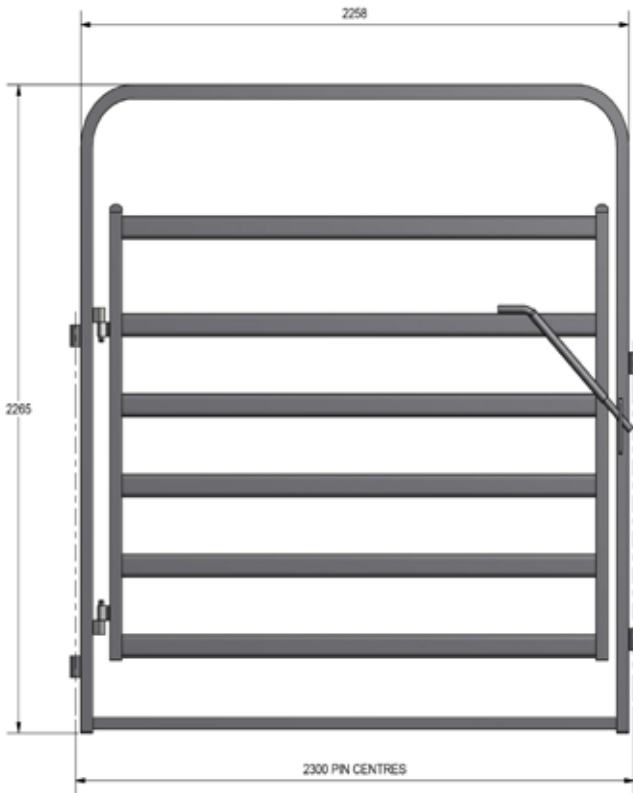
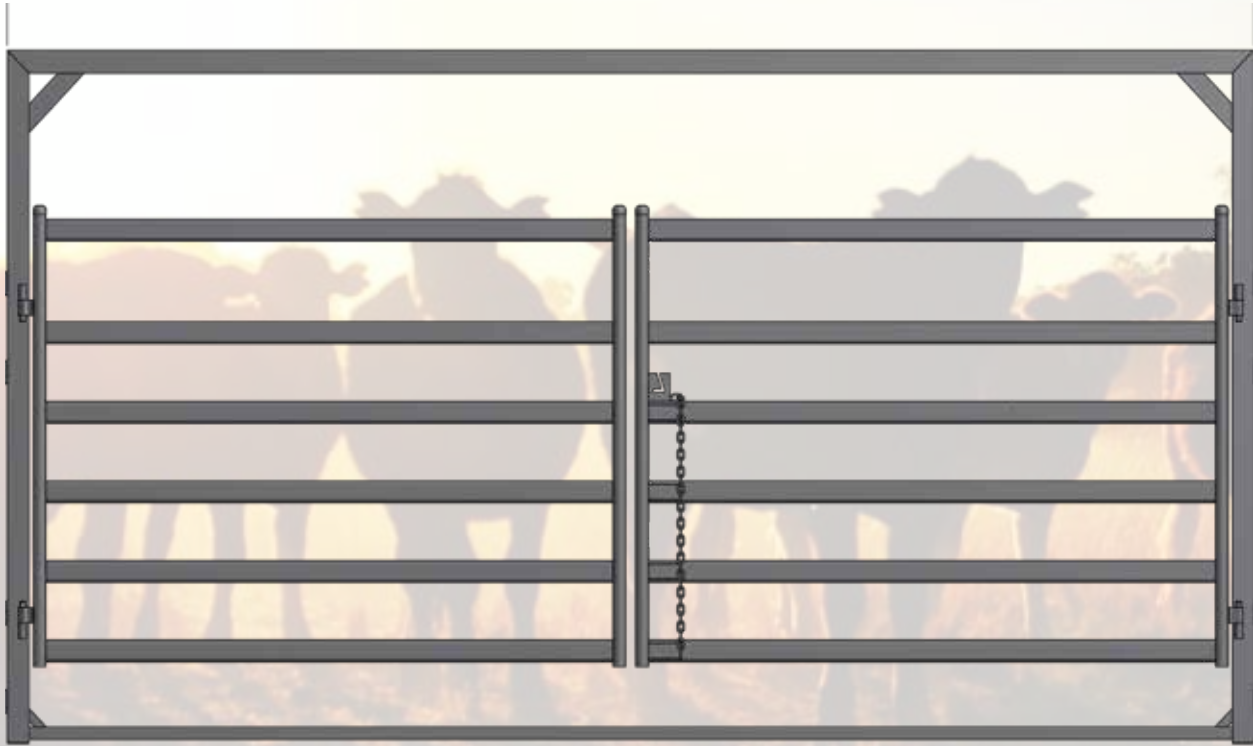

Oval Gate in Frame

- ▲ 2300 L x 2260 H
- ▲ 6 Rail - 75 x 40 x 2mm
- ▲ Bow/Uprights- 50 x 50 x 2mm
- ▲ Latch options - drop pin, cam handle & chain

Weight - 78 kgs

Product Code: 21001001

Premier Gate in Frame

- ▲ 2300 L x 2260 H
- ▲ 5 Rail - 115 x 42 x 2mm
- ▲ Bow/Uprights - 50 x 50 x 2mm
- ▲ Latch options - drop pin, cam handle & chain
- ▲ Weight - 88 kgs

Product Code: 21001011

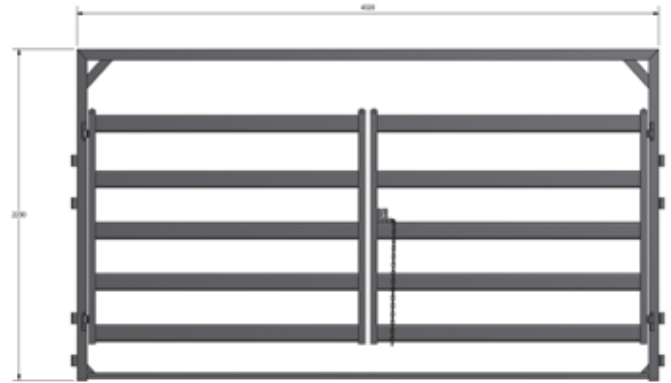

Oval Double Entry Gate

- ▲ 4320 L x 2230 H
- ▲ 6 rail - 75 x 40 x 2mm
- ▲ Bow/Uprights - 75 x 50 x 2.5mm
- ▲ Latch - Chain
- Weight - 146 kgs
- Product Code: 21001001

Premier Double Entry Gate

- ▲ 4320 L x 2230
- ▲ 5 rail - 115 x 42 x 2mm
- ▲ Bow/Uprights - 75 x 50 x 2.5mm
- ▲ Latch - Chain
- ▲ Weight - 160 kgs
- Product Code: 21001011

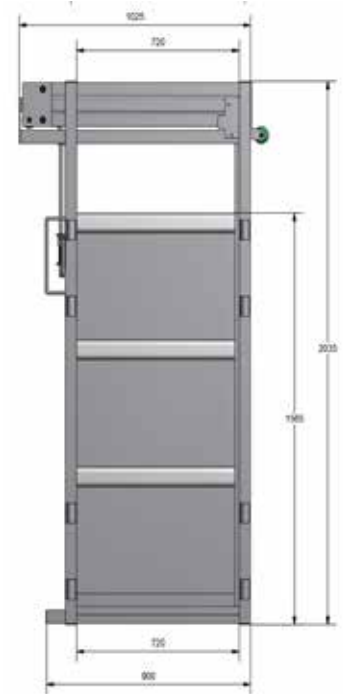
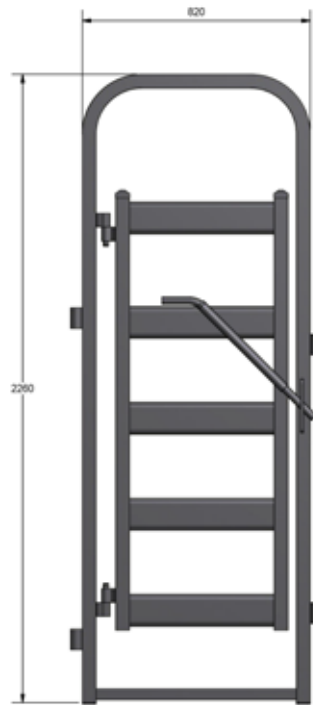
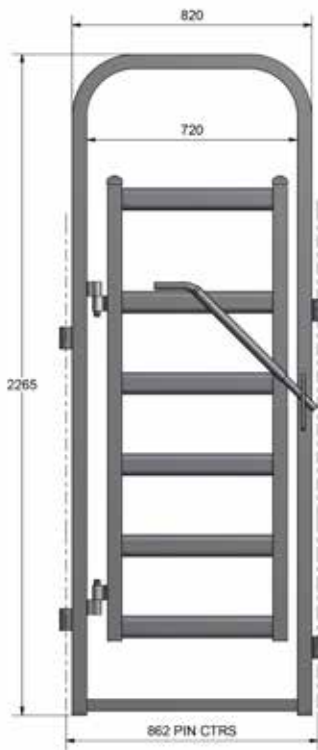

Oval Rail Personnel Gate

- ▲ 820 L x 2260 H
- ▲ 6 rail - 75 x 40 x 2mm
- ▲ Bow/Uprights - 50 x 50 x 2mm
- Weight - 39 kgs
- Product Code: 20906000

Premier Personnel Gate

- ▲ 820 L x 2260 H
- ▲ 5 rail - 115 x 42 x 2mm
- ▲ Bow/Uprights - 50 x 50 x 2mm
- Weight - 42 kgs
- Product Code: 20907000

One Way Sliding Gate

- ▲ 900 L x 2035 H
- ▲ 720mm walk through
- ▲ Frame - 50 x 50 x 2.5mm
- ▲ Sheet - 1.6mm gal
- Weight - 105 kgs
- Product Code: 22501000

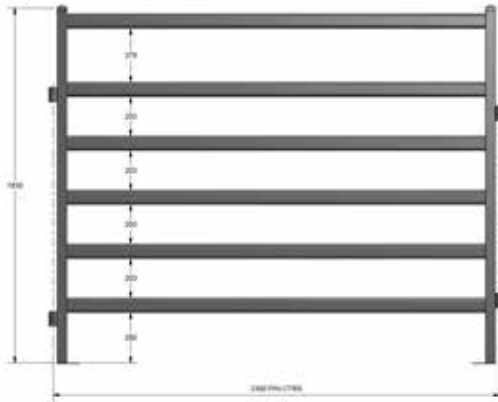

Oval Rail Panel

- ▲ 2300 L x 1830 H
 - ▲ 6 Rail - 75 x 40 x 2mm
 - ▲ Uprights - 50 x 50 x 2mm
- Weight - 50 kgs

Product Code:
 20400040 - 1700 Oval Rail Panel
 20480402W-AU - 2050 Oval Rail Panel
 20480402-AU - 2300 Oval Rail Panel
 20400017 - 3000 Oval Rail Panel

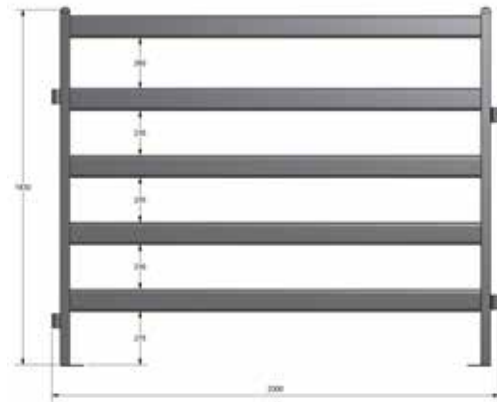

Premier Rail Panel

- ▲ 2300 L x 1830 H
 - ▲ 5 Rail - 115 x 42 x 2mm
 - ▲ Uprights - 50 x 50 x 2mm
- Weight - 60 kgs

Product Code:
 20402150 - Aust. 2050 Premier Panel
 20402100 - Aust. 2300 Premier Panel

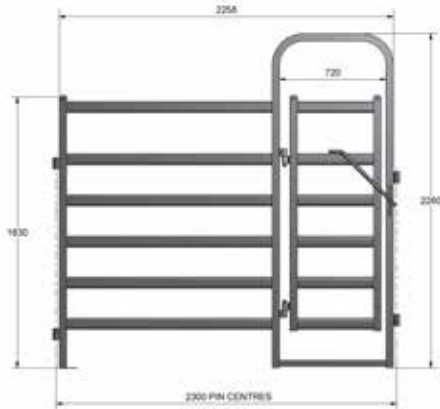

Oval Personnel Access Panel

- ▲ 2300 L x 2260 H
 - ▲ 6 rail - 75 x 40 x 2mm
 - ▲ Bow/Uprights - 50 x 50 x 2mm
- Weight - 69 kgs

Product Code: 20907000



Premier Personnel Access Panel

- ▲ 2300 L x 2260 H
 - ▲ 5 rail - 115 x 42 x 2mm
 - ▲ Bow/Uprights - 50 x 50 x 2mm
- Weight - 77 kgs

Product Code: 20402160

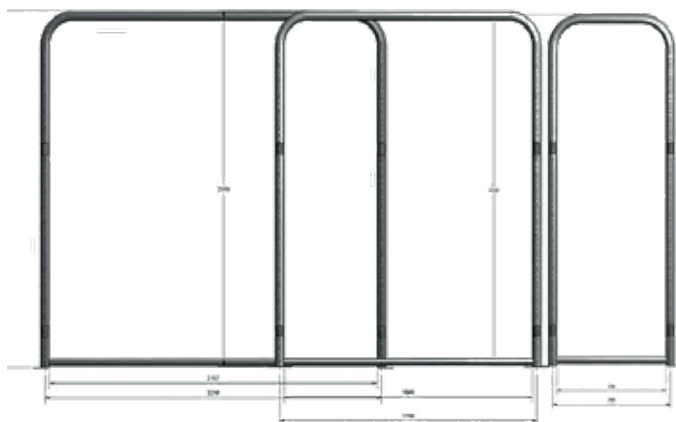

Race Bow

- ▲ Large and medium yard bow
 - ▲ Race bow
 - ▲ 50 x 50 x 2mm SHS bows
- Product Code: 23001000



Panels & Gates

Gates are Australian made

- ▲ ANY size gate can be made, give us a call if you need something special!
- ▲ Gate in frame, we make gates either standard or forcing
- ▲ Standard Gates, swing BOTH directions 90 degrees
- ▲ Forcing Gates, swing ONE direction 180 degrees



Locally made tough, for Australian cattle

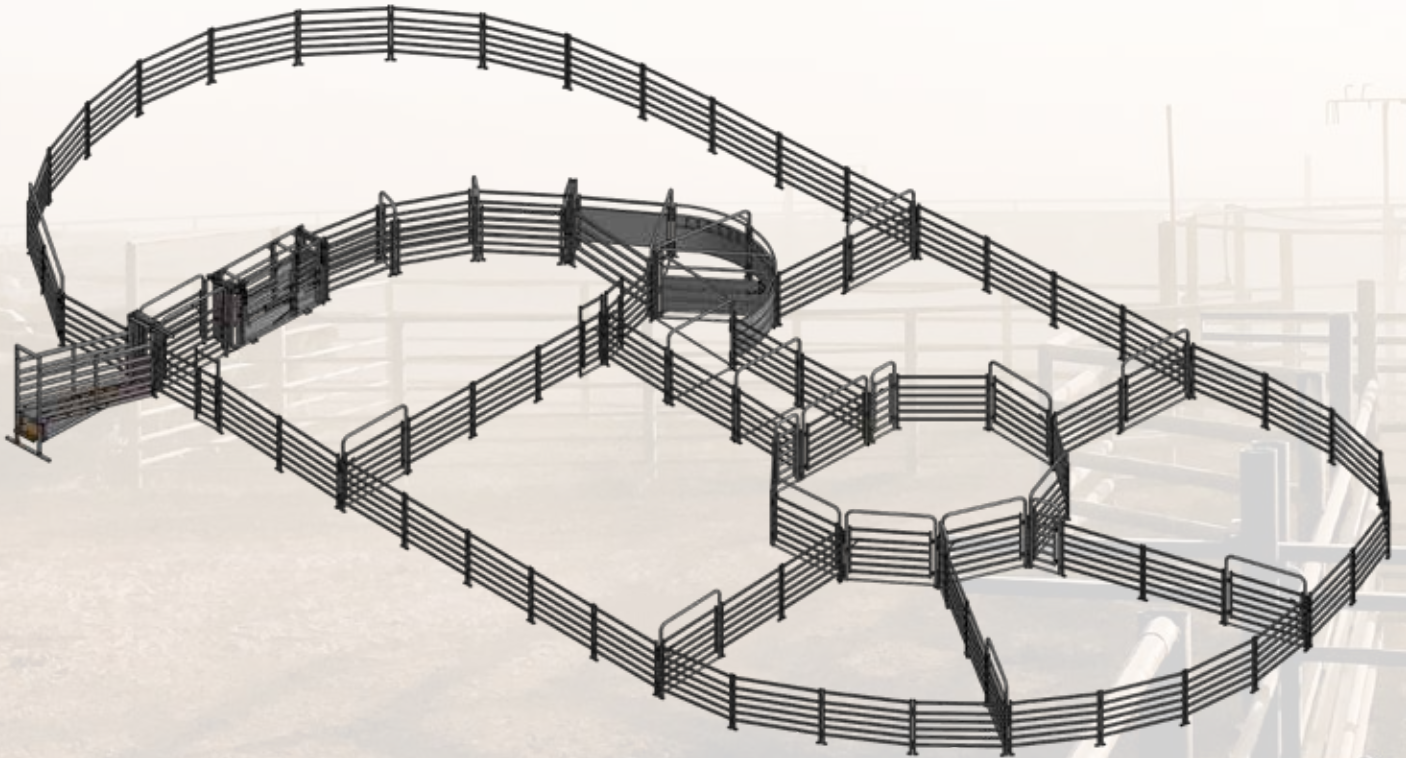

Cattleyard Systems

RPM Livestock Equipment are able to offer Cattleyards to suit cattle producers ranging from the family farm set up to a busy lot feeder operation. Standard packages start from the 30/20 yard with good access points for operator safety, a choice of crushes and loading ramps to adjust the yard to suit your operation. RPM, no matter what size and configuration is required, will work in with you to deliver the solution to suit your cattle production.

Fully customised cattleyards are also available with our inhouse draftsman able to design a solution to suit your specifications. To see how we can help please contact our office in Gatton.



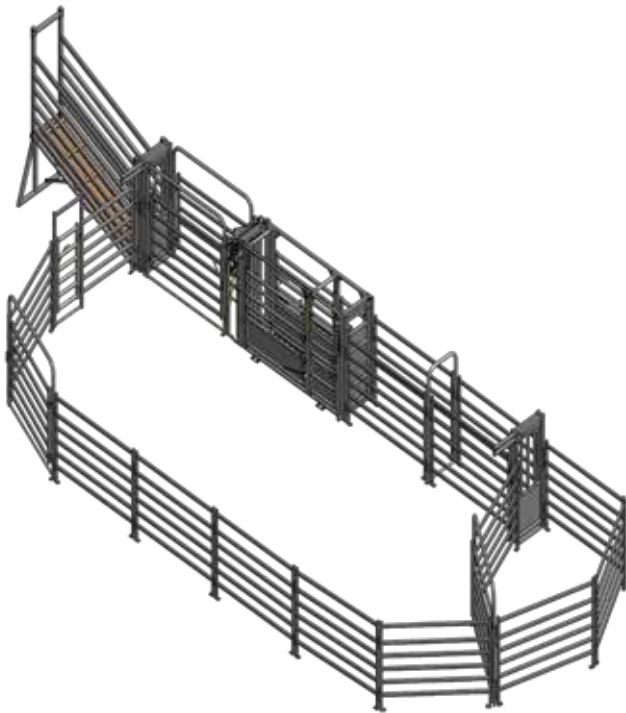

30/20 Yard System

- ▲ Personal access panel
- ▲ Sliding gate x 2
- ▲ Gates x 4
- ▲ Std race bow
- ▲ 3 Way post
- ▲ Panels
- ▲ 6.10 M x 14.36 M + 2.3m
- ▲ 61m²

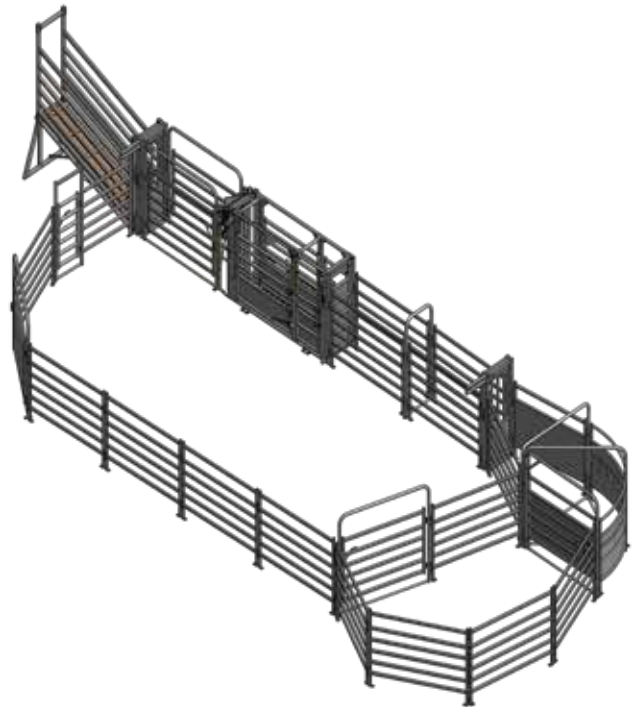

60/35 Yard System

- ▲ Personal access panel
- ▲ Sliding gate
- ▲ Gates x 4
- ▲ Std race bow
- ▲ Panels
- ▲ SAFE - T - FORCE
- ▲ 7.7 M x 16.4 M + 2.3m
- ▲ 67m²

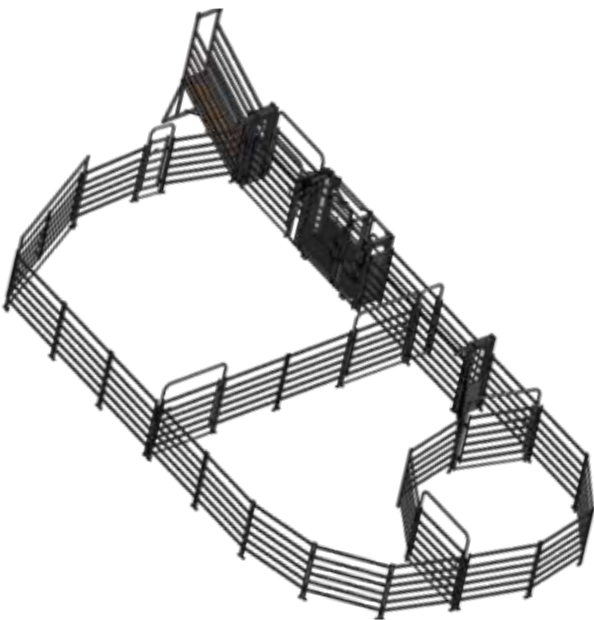

80/45 Yard System

- ▲ Personal gate
- ▲ Sliding gate x 2
- ▲ Gates x 6
- ▲ Double entry gate
- ▲ Std race bow
- ▲ Race bow nearside takeoff
- ▲ Panels
- ▲ 10.1 M x 18.7 M + 2.3m
- ▲ 77m² + 56m²

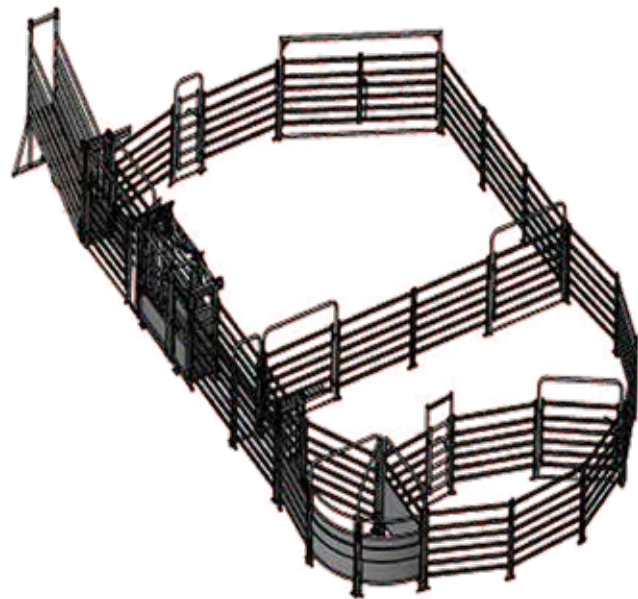

80/45 Yard System with Safe-T-Force

- ▲ Personal gate, Sliding gate x 2
- ▲ Gates x 6
- ▲ Double entry gate
- ▲ Std race bow
- ▲ Panels
- ▲ Race bow nearside takeoff
- ▲ SAFE - T - FORCE
- ▲ 10.1 M x 18.7 M + 2.3m
- ▲ 77m² + 56m²

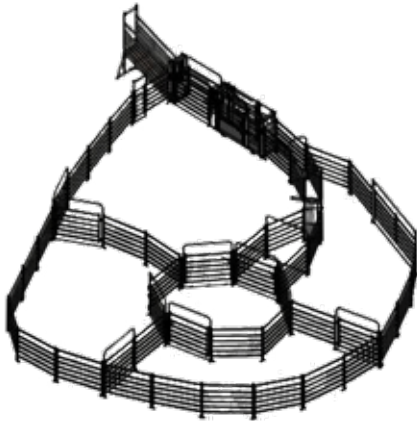

110/80 Yard System

- ▲ Personal gate
- ▲ Sliding gate
- ▲ Gates x 11
- ▲ Double entry gate
- ▲ Panels
- ▲ 20.5 m x 19.2 m
- ▲ 92m² + 55m² + 41m²,
46m² + 25m² + 8m²

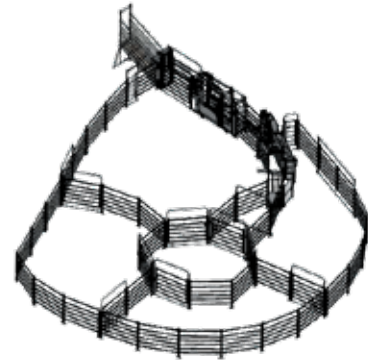

110/80 Yard System with Calf Race

- ▲ Personal gate
- ▲ Sliding gate
- ▲ Gates x 11 + Panels
- ▲ Double entry gate
- ▲ Calf race
- ▲ 20.5 m x 19.2 m
- ▲ 92m² + 55m² + 41m²,
46m² + 25m² + 8m²

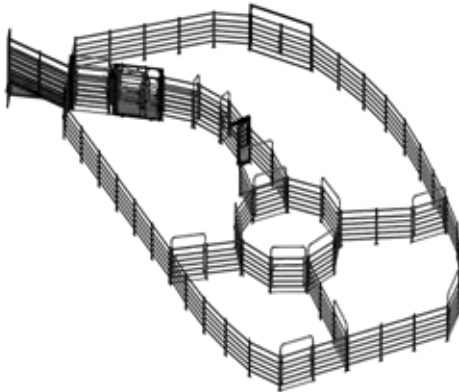

200/140 Yard System

- ▲ Personal access gate
- ▲ Sliding gate x 2
- ▲ Gates x 12
- ▲ Double entry gate
- ▲ Race box x 2
- ▲ 3 way post x 6
- ▲ Panels
- ▲ 20.1 m x 29.3 m
- ▲ 106m² + 61m² + 77m²,
173m² + 33m² + 12m²

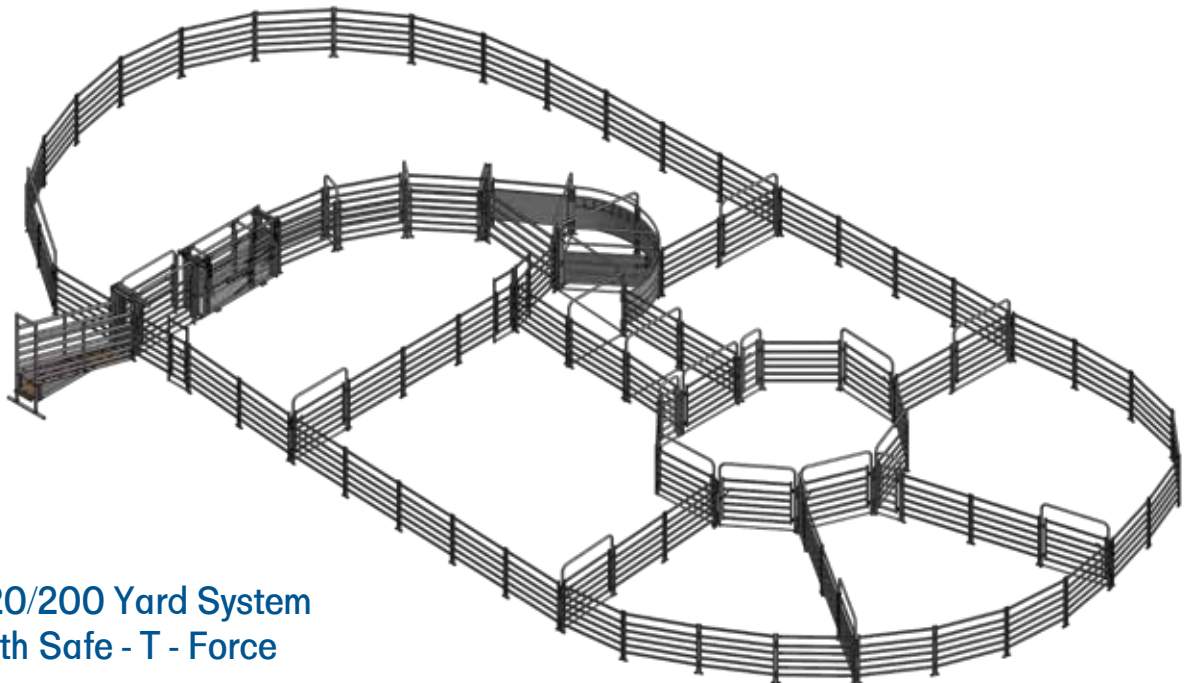

320/200 Yard System with Safe - T - Force

- ▲ 3m 3 section safe-t-force nearside
- ▲ Double entry gate
- ▲ Oval rail gate x 9
- ▲ Oval rail personnel gate x 4
- ▲ Personal access panel oval rail x 3
- ▲ One way sliding gate
- ▲ Oval rail panel x 60
- ▲ Weean oval rail panel x 3
- ▲ Yard bow 2215 ctrs x 2
- ▲ Std race bow x 2
- ▲ 3 Way post x 13
- ▲ 320/200 available without Safe - T - Force



AIR EQUIPMENT



Ultimate Air Crush

To provide Cattle Operators the pinnacle in low stress cattle handling equipment, RPM offer the Ultimate Air Crush.

The Ultimate Air Crush utilises the best of the pneumatic technology and RPM's experience of over 30 years in cattle handling production to manufacture a silent crush with super squeeze strength. Designed for the ultimate in safety for the operator and cattle, this crush saves time, protects your livestock, is simple to operate and needs less staff manage the workflow. The Ultimate Air Crush is the definitive pneumatic crush that includes numerous pieces of equipment as standard, plus other options to maximise your cattle handling productivity while ensuring the safety of your staff and cattle.

- ▲ Air Powered
 - ▲ Ability to operate manually
 - ▲ Heavy Duty Crush, High Tensile Galvanised Steel
 - ▲ Small Feedlot/Large Commercial Operation
 - ▲ Parallel Double Sided Squeeze
 - ▲ Spey & Injection Gates
 - ▲ Swing-Away Control Panel Operation
 - ▲ 100mm Pneumatic Cylinders on Bail and Squeeze - Fully Speed Controllable
 - ▲ Rose Joint Bearing Linkage
 - ▲ Hydra Lock Headbail and Squeeze
 - ▲ Front and Rear Operation Standard
 - ▲ Straight Rubber Lined Headbail Doors
 - ▲ Ball Bearing Headbail Pivot
 - ▲ Sound Proofing
 - ▲ Reduced Labour Costs
 - ▲ Powerlock Linkage
 - ▲ Offside and Nearside Available
- Extras: Not included in the standard model
- ▲ Rubber Lined Floor, Drop-In Steel Floor, Hydra Headlock, Muger Style Headlock, Air Headlock, Semen Collection Gate.

Product Code: 23001000



Air Headbail

- ▲ Pneumatic Superlock Headbail
- ▲ Full walk through
- ▲ Rubber lined doors
- ▲ Option to operate manually or air assisted
- ▲ Quick, quiet close and release
- ▲ Reduced manual labour

Product Code: Nearside 16001000-NS, Offside 16001000-OS



3-Way Air Drafter

- ▲ Pneumatic 3 way drafting
- ▲ Galvanised construction
- ▲ 720mm walk through
- ▲ 75x40x2mm oval rail gates
- ▲ 50x50 SHS main frame
- ▲ Adding additional modules will create 5 or 7 drafters

Product Code: 15702018



Air Sliding Gate

- ▲ Pneumatic sliding gate
- ▲ More efficient in reducing walking distance and labour
- ▲ Split doors for quicker closing to baulk and block animals
- ▲ Can be operated by push button at the gate or from the control panel connected at the Crush

Product Code: 22504100



Cam Handle

- ▲ With Striker Plate

Product Code:

Nearside 26000022, Offside 126000018



Pins

- ▲ Long Pins/Short Pins



Wheels

- ▲ Headbail Wheels - 76.5mm
- ▲ Slider Wheels - 63.5mm



Seal Kits

- ▲ Seals for Struts

Product Code: 18021004



Calf Cradle/Headlock Strut

- ▲ Strut for headlock - hydra/mugger and strut for calf cradle



Headbail Strut

- ▲ Old Style: approx 1100mm long
- ▲ New Style: approx 750mm long



Overhead Squeeze Strut

- ▲ Used on parallel squeeze crushes only
- ▲ Has oil reservoir tank on the top ram



Old Style Headbail Strut

- ▲ Approx 1100mm long
- ▲ Holds approx 450ml light hydraulic oil, (maroon/orange/blue)
- ▲ Holds approx 500ml light hydraulic oil, (yellow)

To order your parts contact us @ RPM.

To maintain your equipment visit our website for spec sheets and handy tips.



07 5462 3433



sales@rpmrural.com



rpmrural.com



RPM
LIVESTOCK EQUIPMENT



Ph 07 5462 3433 | www.rpmrural.com
sales@rpmrural.com | 3 Industrial Road, Gatton, Qld 4343